



Rockford Sanitary Systems, Inc.

ROCKFORD, IL 61125-0963

(815) 229-5077 - (800) 747-5077 - FAX (815) 229-5108

WEB SITE-www.rkfdseparators.com E MAIL-rssem@rkfdseparators.com

MODEL NO. RP-125

GREASE INTERCEPTOR

DRAWN BY

QUOTE #

JOB NAME

W.R.W.

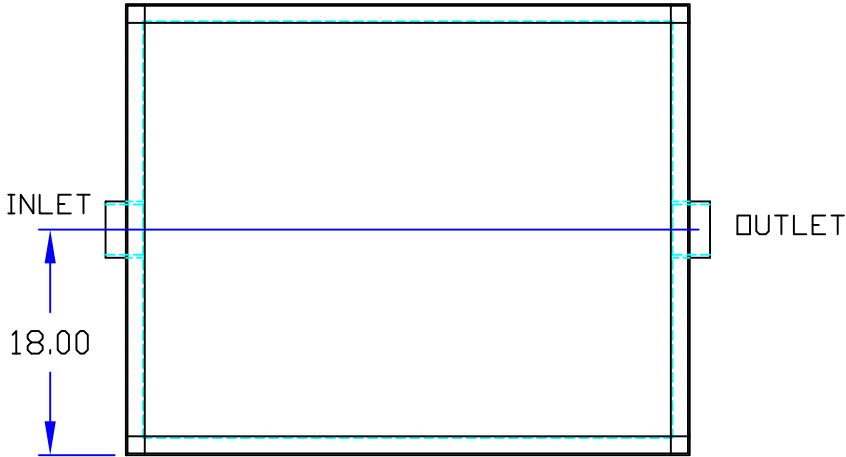

OPTIONAL FEATURES (ADDITIONAL COST)

- ANCHOR FLANGE
- EPOXY COATING
- STAINLESS STEEL CONSTRUCTION
- INTEGRAL EXTENSION _____ INCHES
- INLET & OUTLET SIZE _____ INCHES
- ALUMINUM COVER
- THREADED CONNECTIONS

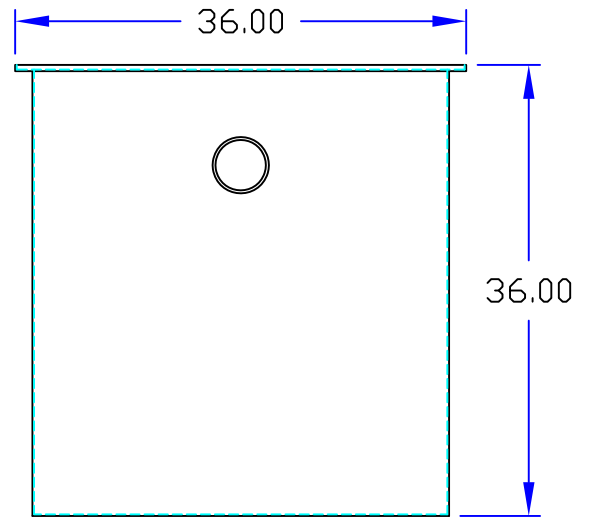
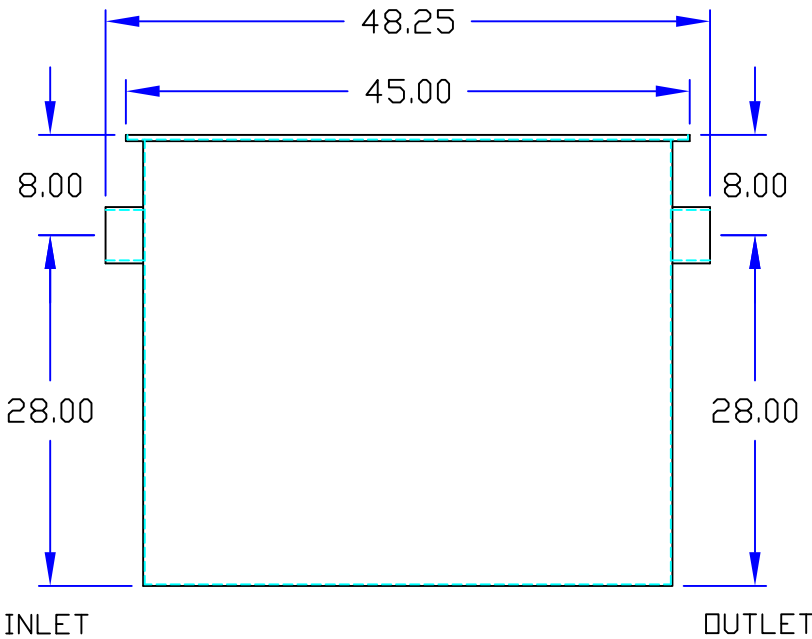

Specifications

Rockford Model RP-125 all welded steel interceptor, for on the floor or flush with the floor installation, 125 g.p.m. intermittent flow, 250 lbs. grease capacity, 4.00" no-hub inlet and outlet connections and flow control device, removable 3/16" nonskid diamond treadplate cover for on the floor or flush with floor installation suitable for pedestrian traffic, secured with stainless steel flat head screws, heavy duty leak-proof gasket, enamel coating inside and outside

Optional features (Additional cost) listed above



Approved By

Company

Date