



Rockford Sanitary Systems, Inc.

ROCKFORD, IL 61125-0963

(815) 229-5077 - (800) 747-5077 - FAX (815) 229-5108

WEB SITE-www.rkfdseparators.com E MAIL-rssem@rkfdseparators.com

MODEL NO. R-POLY-10

GREASE INTERCEPTOR

DRAWN BY

QUOTE #

JOB NAME

W.R.W.

OPTIONAL FEATURES (ADDITIONAL COST)

- INLET & OUTLET SIZE _____ INCHES
- ALUMINUM COVER

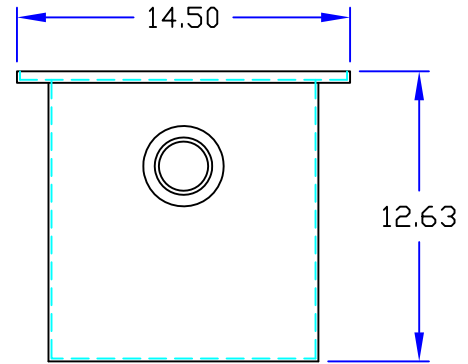
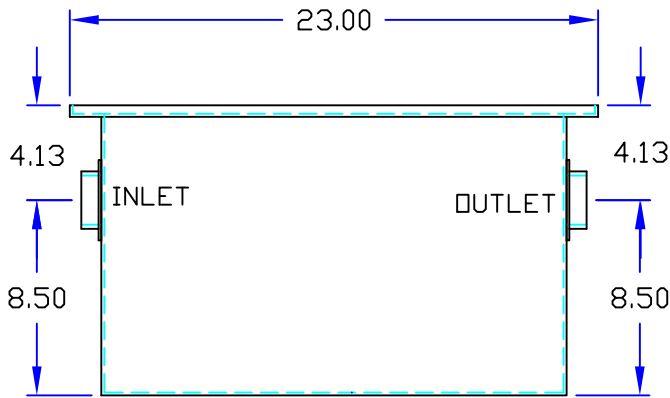
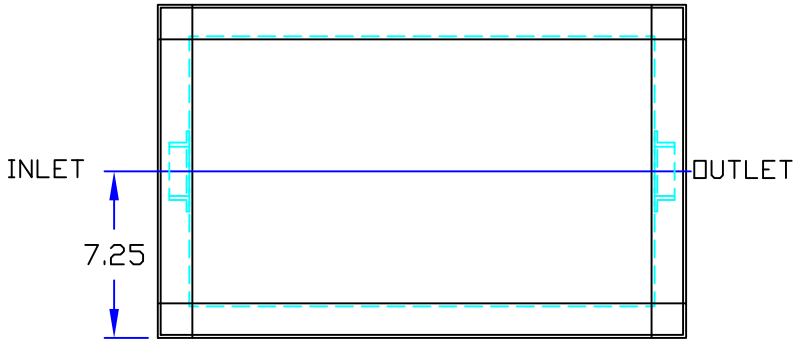

Specifications

Rockford Model R POLY 10, polyethylene interceptor, for on the floor or flush with the floor installation, 10 g.p.m. intermittent flow, 20 lbs. grease capacity, 2.00" threaded inlet and outlet connections and flow control device, removable nonskid polyethylene cover for on the floor or flush with floor installation suitable for pedestrian traffic, secured with stainless steel screws, leak-proof gasket

Optional features (Additional cost) listed above

Approved By

Company

Date