



Rockford Sanitary Systems, Inc.

ROCKFORD, IL 61125-0963

(815) 229-5077 - (800) 747-5077 - FAX (815) 229-5108

WEB SITE-www.rkfdseparators.com E MAIL-rssem@rkfdseparators.com

MODEL NO. R-POLY-200

GREASE INTERCEPTOR

DRAWN BY

QUOTE #

JOB NAME

W.R.W.

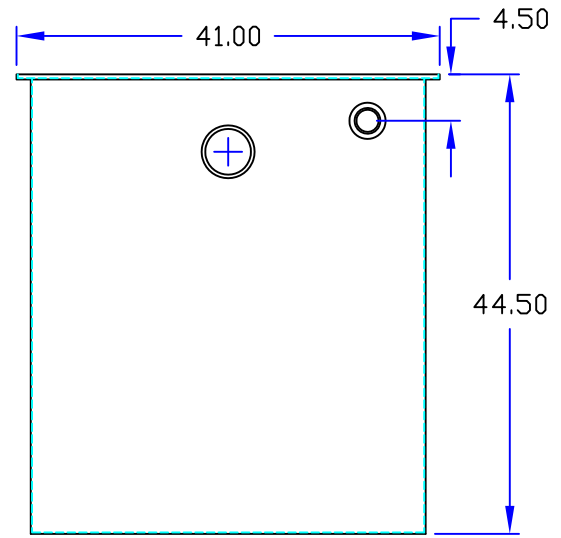
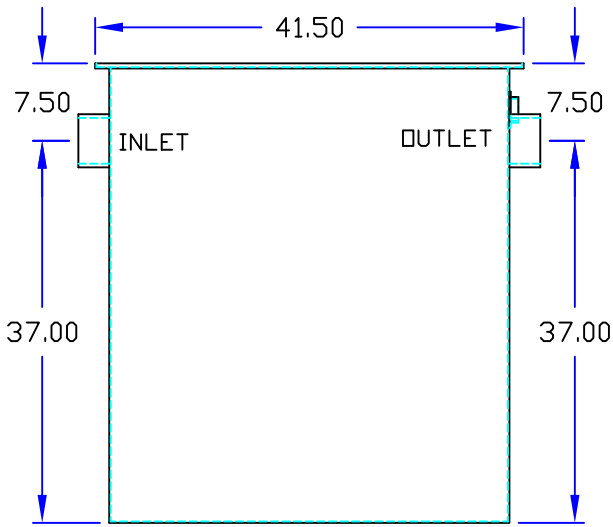
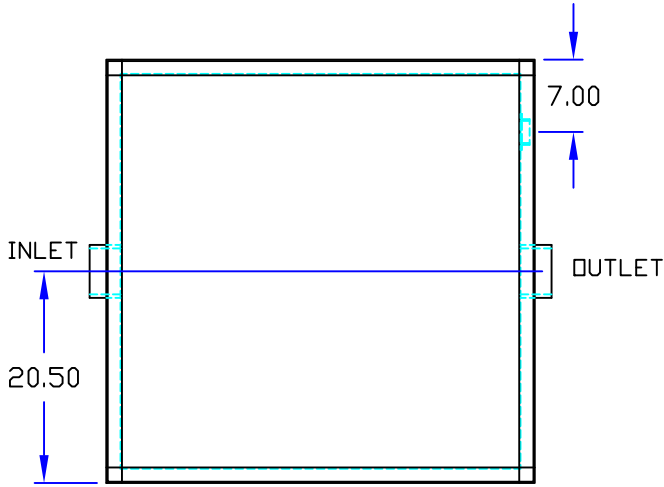

Specifications

Rockford Model R POLY 200 polyethylene interceptor, for on the floor or flush with the floor installation, 200 g.p.m. intermittent flow, 500 lbs. grease capacity, 4.00" glue fit inlet and outlet connections and flow control device, multiple removable polyethylene covers for on the floor or flush with floor installation suitable for pedestrian traffic, secured with stainless steel screws, heavy duty leak-proof gasket, 2" threaded vent connection

Optional features available upon request (additional cost)

Approved By

Company

Date