



Rockford Sanitary Systems, Inc.

ROCKFORD, IL 61125-0963

(815) 229-5077 - (800) 747-5077 - FAX (815) 229-5108

WEB SITE-www.rkfdseparators.com E MAIL-rssem@rkfdseparators.com

MODEL NO. RP-20SS

GREASE INTERCEPTOR

DRAWN BY

QUOTE #

JOB NAME

W.R.W.

OPTIONAL FEATURES (ADDITIONAL COST)

THREADED CONNECTIONS

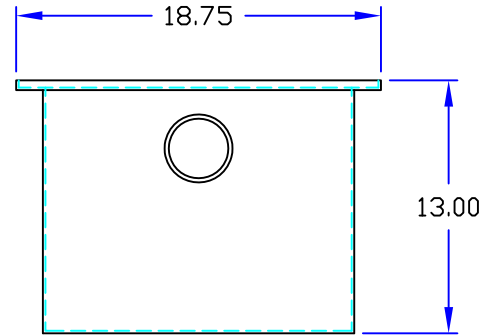
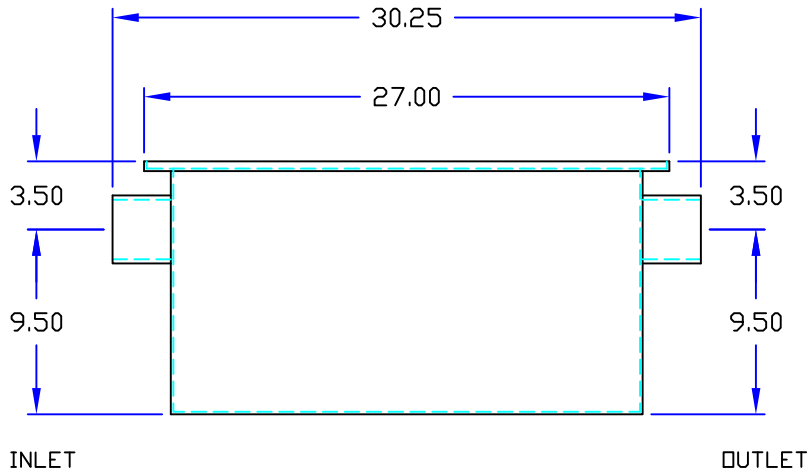
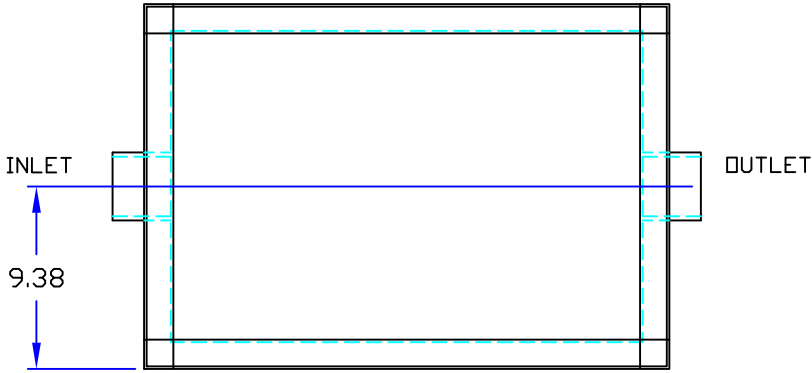

Specifications

Rockford Model RP-20SS all welded stainless steel interceptor, with 20 gpm intermittent flow, 77 lbs. grease capacity, 3.00" no-hub inlet and outlet connections and flow control device, removable 3/16" nonskid diamond tread-plate cover for on the floor or flush with floor installation suitable for pedestrian traffic, secured with stainless steel flat head screw, heavy duty leak-proof gasket.



Approved By

Company

Date