



# ROCKFORD SEPARATORS

5159 28th Ave ROCKFORD, IL 61109  
(815) 229-5077 - FAX (815) 229-5108  
www.rkfdseparators.com - rssem@rkfdseparators.com

MODEL NO. G-30-LO-M

GREASE SEPARATOR

DRAWN BY R.P.P.

QUOTE#:

JOB NAME:

### OPTIONAL FEATURES (ADDITIONAL COST)

- EPOXY COATING
- STAINLESS STEEL CONSTRUCTION
- SEDIMENT BASKET  FILTER MEDIA
- DRAW OFF VALVE
- ALTERNATE INLET & OUTLET SIZE \_\_\_\_\_ INCHES
- CAST IRON OUTLET FITTINGS
- PVC OUTLET FITTINGS

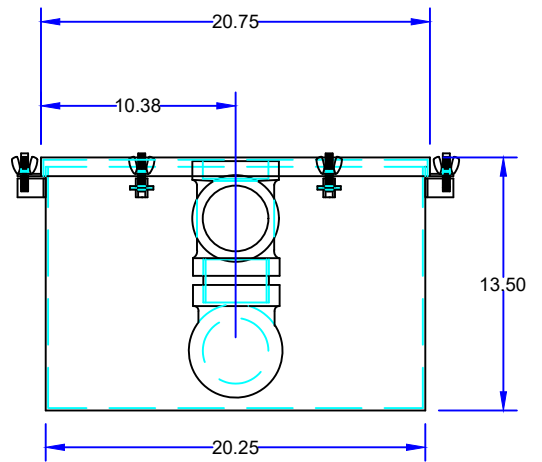
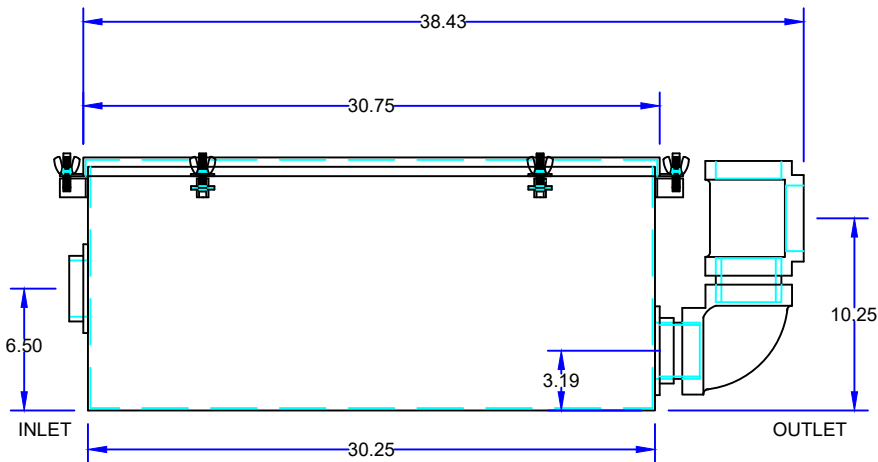
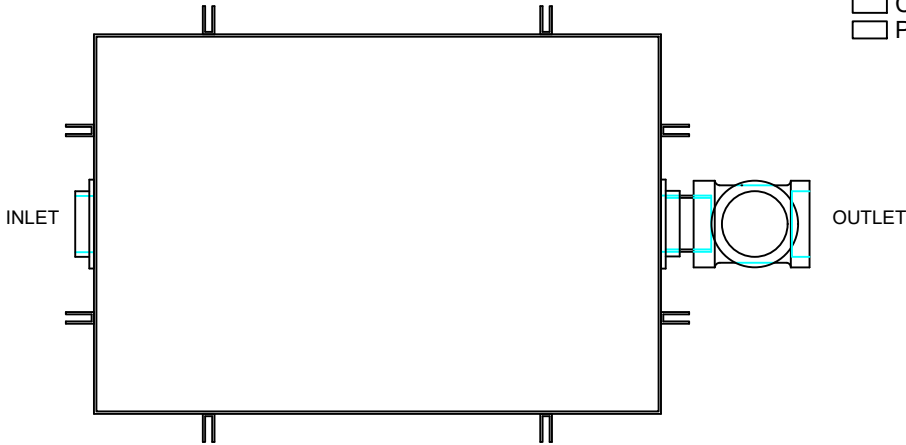

## SPECIFICATIONS

Rockford Model G-30-LO-M all welded 10 Ga. steel separator, 23 gallon static capacity, 30 g.p.m. intermittent flow, 3.00" tapped inlet and outlet connection, 116 lbs. greasy sludge capacity, visible double-wall outside trap seal, easily removable filter screen gasketed cover hand-tightened to body with safety-catch bolt assemblies, enamel coated inside and outside.

Optional features (Additional cost) listed above

Approved By

Company

Date