



ROCKFORD SEPARATORS

5159 28th Ave ROCKFORD, IL 61109
(815) 229-5077 - FAX (815) 229-5108
www.rkfdseparators.com - rssem@rkfdseparators.com

MODEL NO. G-30-LO-R

GREASE SEPARATOR

DRAWN BY R.P.P.

QUOTE#:

JOB NAME:

OPTIONAL FEATURES (ADDITIONAL COST)

- EPOXY COATING
- STAINLESS STEEL CONSTRUCTION
- SEDIMENT BASKET FILTER MEDIA
- DRAW OFF VALVE
- ALTERNATE INLET & OUTLET SIZE _____ INCHES
- CAST IRON OUTLET FITTINGS
- PVC OUTLET FITTINGS

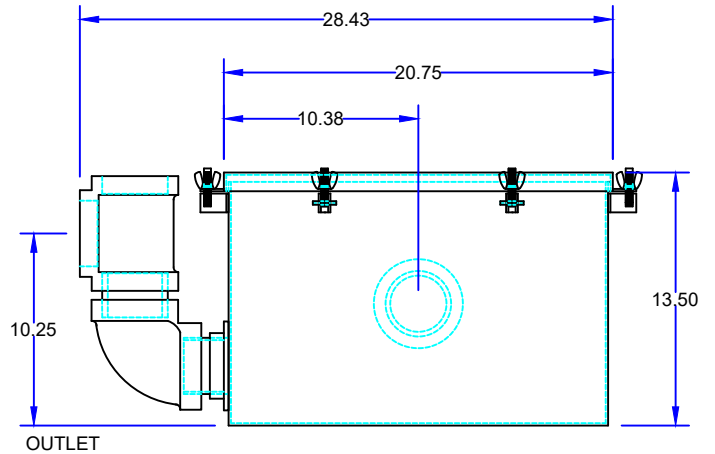
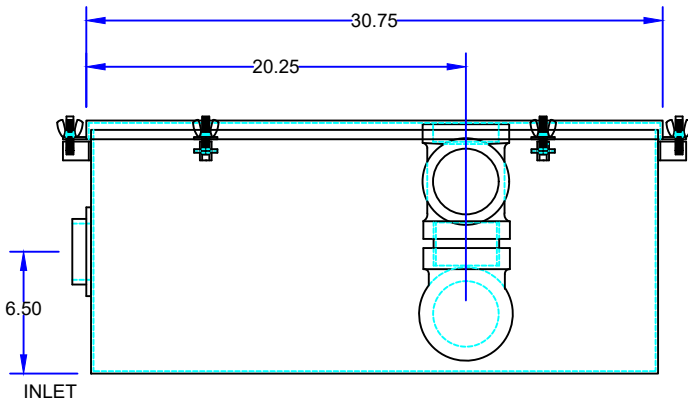
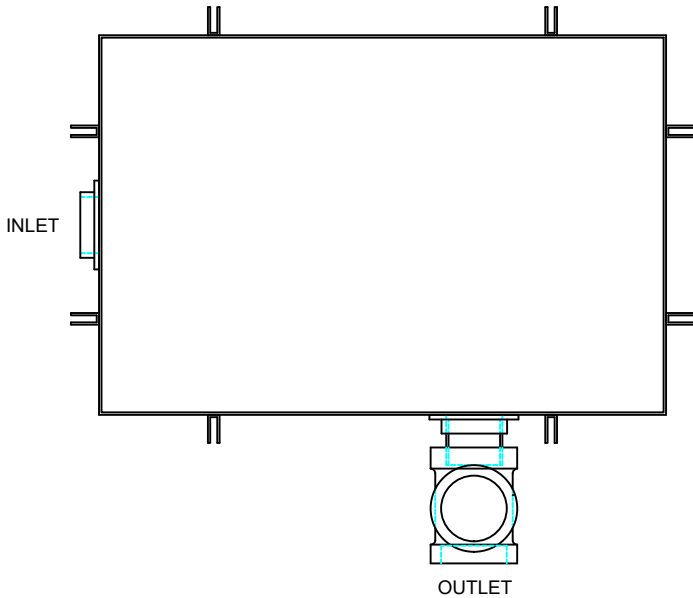

SPECIFICATIONS

Rockford Model G-30-LO-R all welded 10 Ga. steel separator for on the floor (or partially recessed) installation, 30 g.p.m. intermittent flow, 3.00" tapped inlet and outlet connection, 116 lbs. greasy sludge capacity, visible double-wall outside trap seal, easily removable filter screen and separator screen, gasketed cover hand tightened to body with safety catch bolt assemblies, enamel coated inside & outside.

Optional features (Additional cost) listed above

Approved By

Company

Date