



Rockford Sanitary Systems, Inc.

ROCKFORD, IL 61125-0963

(815) 229-5077 - (800) 747-5077 - FAX (815) 229-5108

WEB SITE-www.rkfdseparators.com E MAIL-rssem@rkfdseparators.com

MODEL NO. G-300-C

GREASE SEPARATOR

DRAWN BY

QUOTE #

JOB NAME

W.R.W.

OPTIONAL FEATURES (ADDITIONAL COST)

- EPOXY COATING
- STAINLESS STEEL CONSTRUCTION
- SEDIMENT BASKET FILTER MEDIA
- DRAW OFF VALVE
- ALTERNATE INLET & OUTLET SIZE _____ INCHES

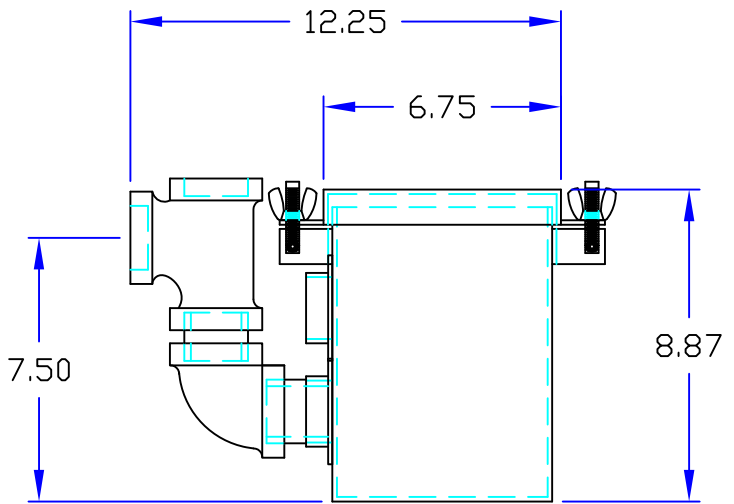
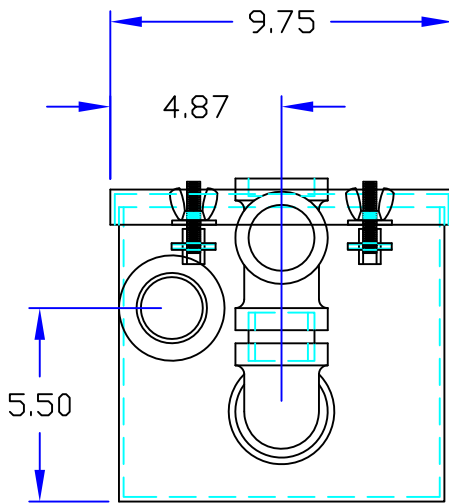
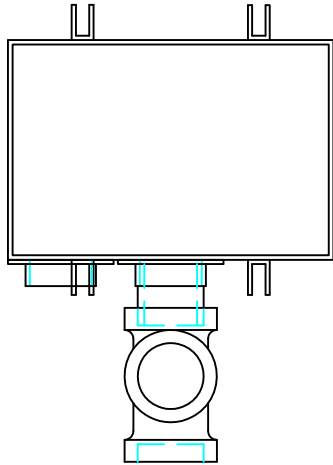

Specifications

Rockford Model G-300-C all welded 10 Ga. steel separator for on the floor (or partially recessed) installation, 4 g.p.m. intermittent flow, 1.50" tapped inlet and outlet connection, 7 lbs. greasy sludge capacity, visible double-wall outside trap seal, easily removable filter screen and separator screen, gasketed cover hand tightened to body with safety catch bolt assemblies, enamel coated inside & outside.

Optional features (Additional cost) listed above



Approved By

Company

Date