



ROCKFORD SEPARATORS

5159 28th Ave ROCKFORD, IL 61109
 (815) 229-5077 - FAX (815) 229-5108
 www.rkfdseparators.com - rssem@rkfdseparators.com

MODEL NO. GF-25-LO-M

GREASE SEPARATOR

DRAWN BY R.P.P.

QUOTE#:

DATE: 03/29/22

JOB NAME:

OPTIONAL FEATURES (ADDITIONAL COST)

- ANCHOR FLANGE
- CLAMP RING
- RECESSED LIFT HANDLES IN COVERS
- EPOXY COATING
- ANODES
- REINFORCED COVER
- STAINLESS STEEL CONSTRUCTION
- SEDIMENT BASKET
- FILTER MEDIA
- INTEGRAL EXTENSION _____ INCHES
- ALTERNATE VENT TAPPING SIZE _____ INCHES
- ALTERNATE INLET & OUTLET SIZE _____ INCHES
- CAST IRON OUTLET FITTINGS
- PVC OUTLET FITTINGS

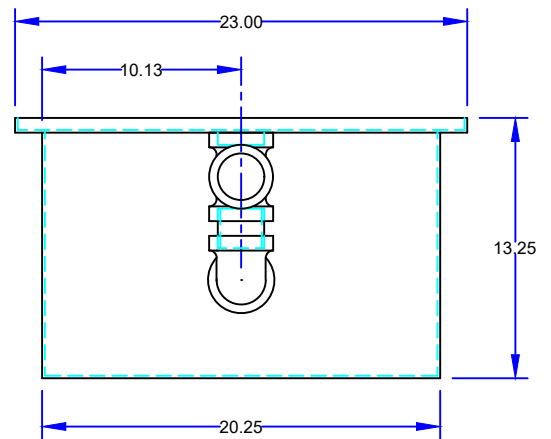
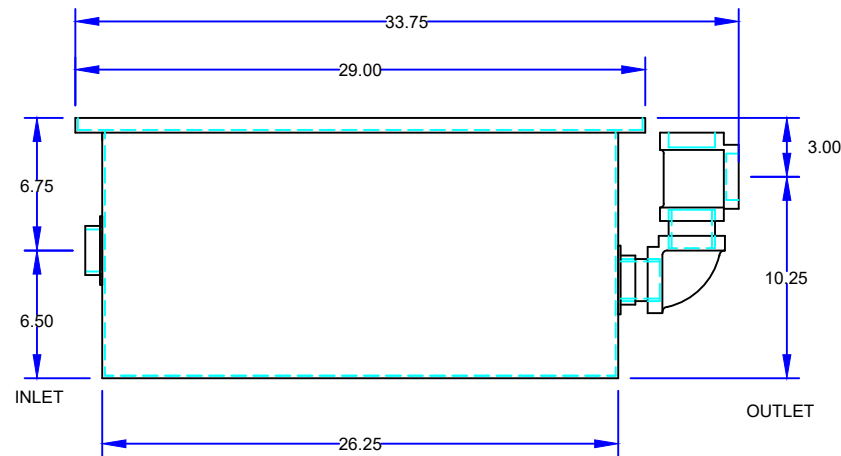
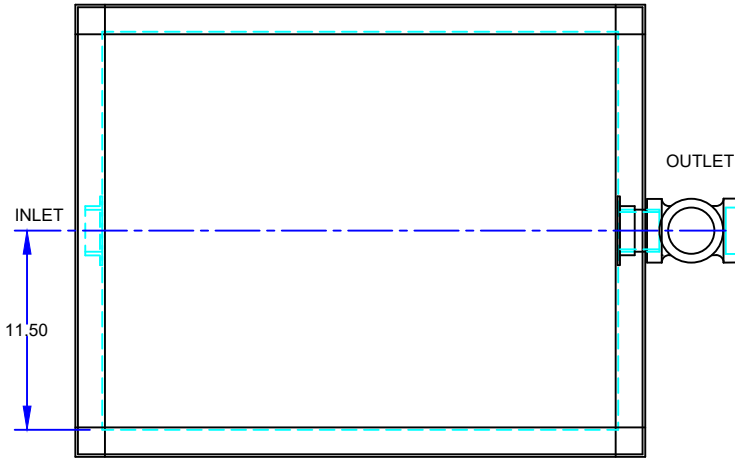

SPECIFICATIONS

Rockford Model GF-25-LO-M all welded 10 Ga. steel separator, 21 gallon static capacity, 20 g.p.m. intermittent flow, 2.00" tapped inlet and outlet connection, 106 lbs. greasy sludge capacity, visible double-wall outside trap seal, easily removable filter screen removable 3/8" nonskid diamond tread-plate cover for flush in the floor installation suitable for pedestrian traffic secured with stainless flat head screws, heavy duty leak-proof gasket, OPEX Shop Coat coating inside and bituminous coating outside.

Optional features (Additional cost) listed above

Approved By

Company

Date