



ROCKFORD SEPARATORS

5159 28th Ave ROCKFORD, IL 61109
 (815) 229-5077 - FAX (815) 229-5108
 www.rkfdseparators.com - rssem@rkfdseparators.com

MODEL NO. OS-5642

OIL / WATER SEPARATOR

DRAWN BY R.P.P.

QUOTE#:

JOB NAME:

OPTIONAL FEATURES (ADDITIONAL COST)

- ANCHOR FLANGE
- RECESSED LIFT HANDLES _____ PER COVER
- EPOXY COATING
- LIGHT TRAFFIC REINFORCED COVERS
- HEAVY TRAFFIC REINFORCED COVERS
- STAINLESS STEEL CONSTRUCTION
- SEDIMENT BASKET
- INTEGRAL EXTENSION _____ INCHES
- INLET & OUTLET SIZE _____ INCHES
- DOUBLE WALL CONSTRUCTION
- LEAK DETECTION
- FILTER MEDIUM
- COALESCING PACK
- ANODES
- HOLD DOWN PADS
- ALUMINUM COVER
- NO HUB CONNECTION
- HUB CONNECTION

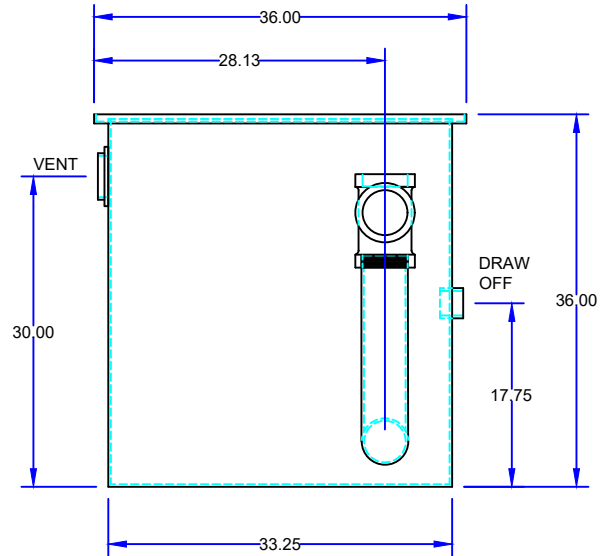
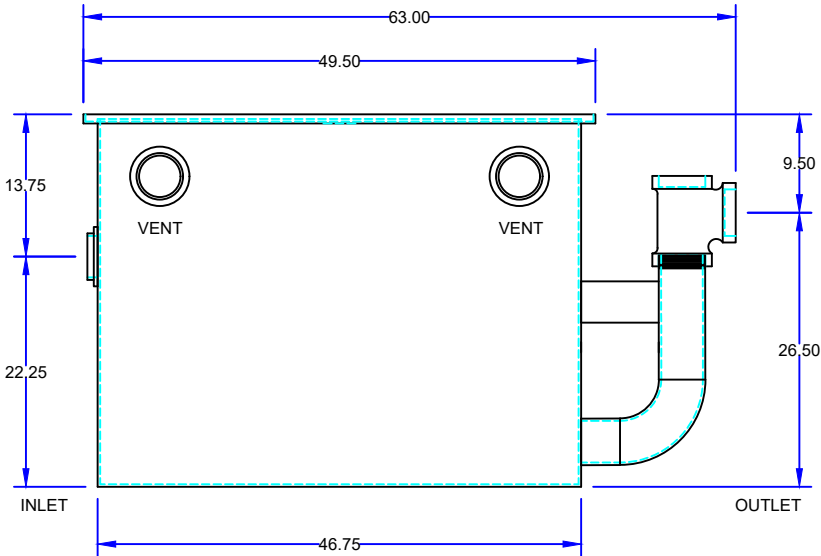
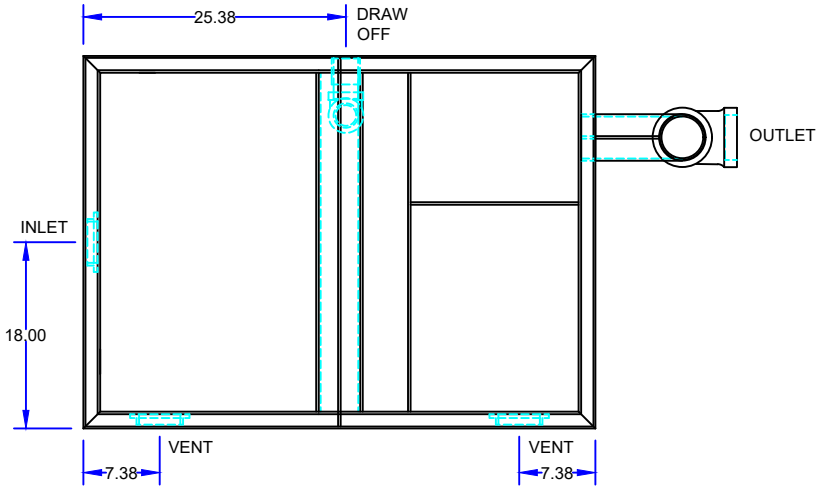

SPECIFICATIONS

Rockford Model OS-5642 Oil/Water Separator all welded A36 1/4" steel, 100 g.p.m. intermittent flow, 172 gallon static capacity, 4.00" Threaded inlet and outlet, 4.00" threaded vent connections (2), 2.00" oil draw-off connection, visible double-wall outside trap seal, removable filter screen, non-removable separator plates, 3/8" nonskid diamond tread plate cover (for flush-with-floor installation) for pedestrian traffic secured with stainless steel bolts with heavy duty leak proof gasket, OPEX SHOP COAT coating inside & bituminous coating outside.

Optional features (Additional cost) listed above

Approved By

Company

Date