



ROCKFORD SEPARATORS

5159 28th Ave ROCKFORD, IL 61109
 (815) 229-5077 - FAX (815) 229-5108
 www.rkfdseparators.com - rssem@rkfdseparators.com

MODEL NO. OST-5633-100

OIL / WATER SEPARATOR

DRAWN BY R.P.P.

QUOTE#:

DATE: 06/01/22

JOB NAME:

OPTIONAL FEATURES (ADDITIONAL COST)

- ANCHOR FLANGE
- RECESSED LIFT HANDLES _____ PER COVER
- EPOXY COATING
- LIGHT TRAFFIC REINFORCED COVERS
- HEAVY TRAFFIC REINFORCED COVERS
- STAINLESS STEEL CONSTRUCTION
- SEDIMENT BASKET
- INTEGRAL EXTENSION _____ INCHES
- INLET & OUTLET SIZE _____ INCHES
- DOUBLE WALL CONSTRUCTION
- LEAK DETECTION
- FILTER MEDIUM
- COALESCING PACK
- ANODES
- HOLD DOWN PADS
- ALUMINUM COVER
- NO HUB CONNECTION
- HUB CONNECTION

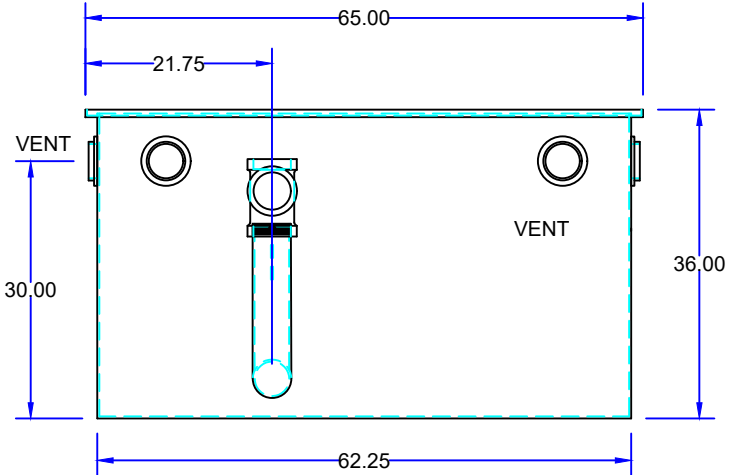
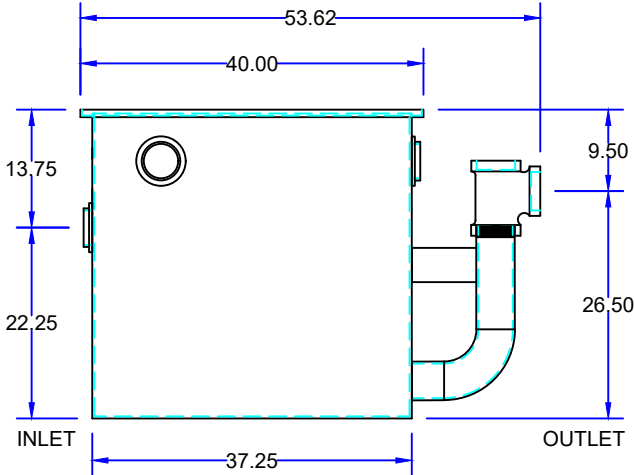
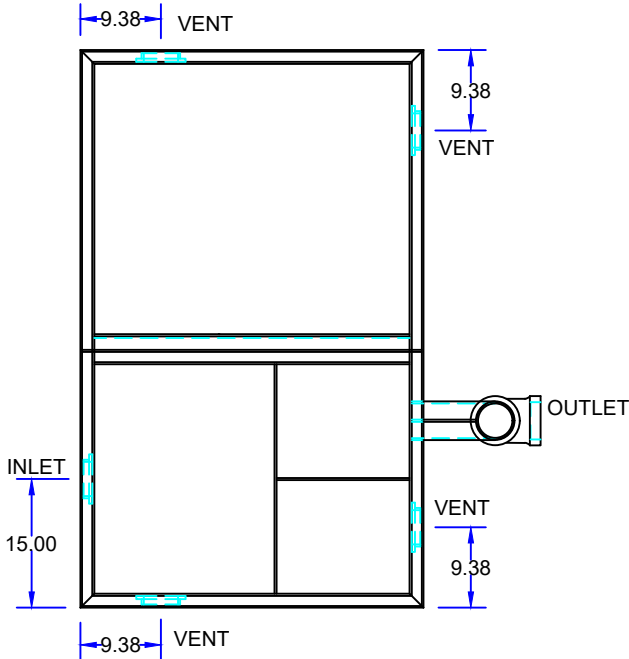

SPECIFICATIONS

Rockford Model OST-5633-100 Oil/Water Separator all welded A36 1/4" steel, 65 g.p.m. intermittent flow, 100 gallon static capacity with 100 gallon waste oil storage, 4.00" threaded inlet/outlet & 4.00" threaded vent connections (4), visible double-wall outside trap seal, removable filter screen, non-removable separator screens, 3/8" nonskid tread plate covers (4) (for flush-with-floor installation) for pedestrian traffic secured with stainless steel bolts with heavy duty leak proof gasket, OPEX SHOP COAT coating inside & bituminous coating outside.

Optional features (Additional cost) listed above

Approved By

Company

Date