



# ROCKFORD SEPARATORS

5159 28th Ave ROCKFORD, IL 61109  
(815) 229-5077 - FAX (815) 229-5108  
www.rkfdseparators.com - rssem@rkfdseparators.com

MODEL NO. R-POLY-350

GREASE INTERCEPTOR

DRAWN BY R.P.P.

QUOTE#:

DATE: 03/13/24

JOB NAME:

OPTIONAL FEATURES (ADDITIONAL COST)

- INLET & OUTLET SIZE \_\_\_\_\_ INCHES
- ALUMINUM COVER

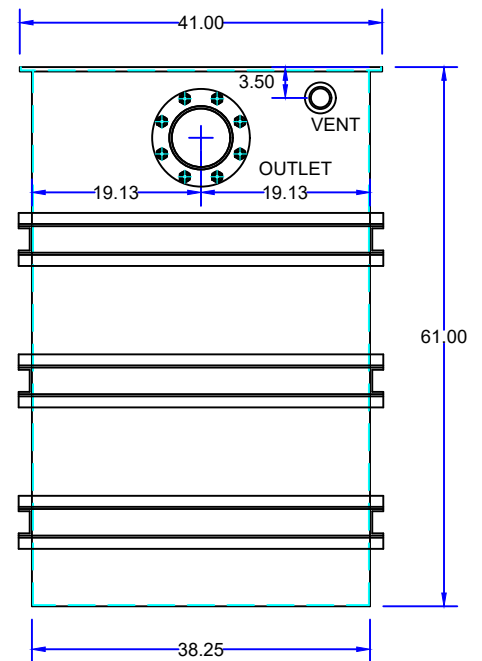
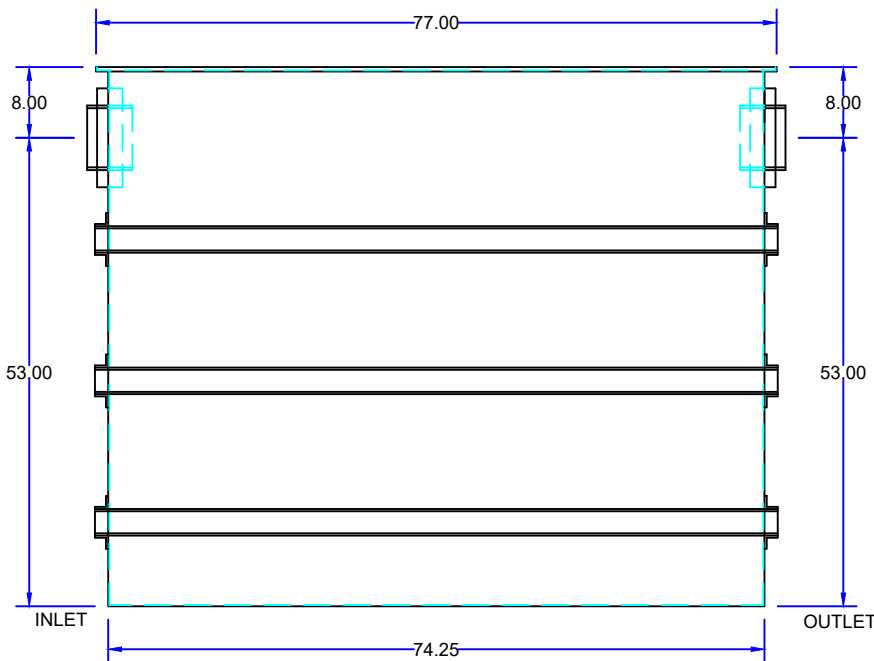
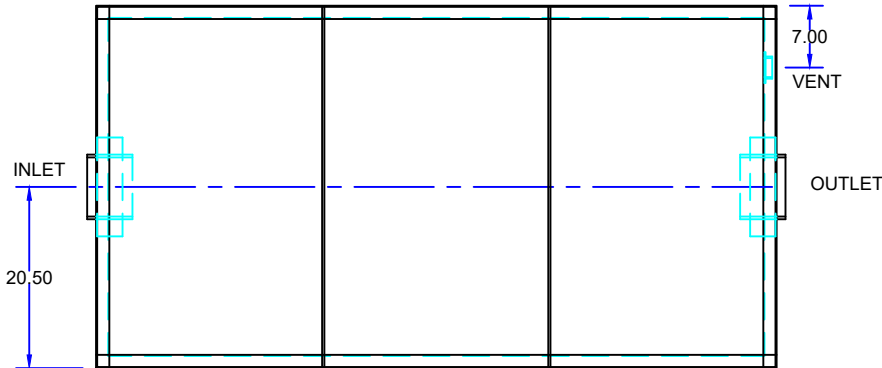

## SPECIFICATIONS

Rockford Model R-POLY-350 polyethylene grease interceptor, for on the floor or flush with floor installation, 350 gpm intermittent flow, 560 gallon static capacity, 600 lbs grease capacity, 6" glue fit in/out connections with a 2" vent connection, multiple removable polyethylene covers suitable for pedestrian traffic, secured with stainless steel screws, heavy duty leak-proof gasket.

NOTE: Integral extensions and bolt-on extensions are not available for the R-Poly series.

Optional features (Additional cost) listed above

Approved By

Company

Date