



ROCKFORD SEPARATORS

5159 28th Ave ROCKFORD, IL 61109
 (815) 229-5077 - FAX (815) 229-5108
 www.rkfdseparators.com - rssem@rkfdseparators.com

MODEL NO. RLS-2635

LINT SEPARATOR

DRAWN BY R.P.P.

QUOTE#:

DATE: 10/10/22

JOB NAME:

OPTIONAL FEATURES (ADDITIONAL COST)

- ANCHOR FLANGE
- RECESSED LIFT HANDLES _____ PER COVER
- EPOXY COATING
- THREADED CONNECTIONS
- HEAVY TRAFFIC REINFORCED COVERS
- STAINLESS STEEL CONSTRUCTION
- INTEGRAL EXTENSION _____ INCHES
- INLET & OUTLET SIZE _____ INCHES
- ALUMINUM COVER

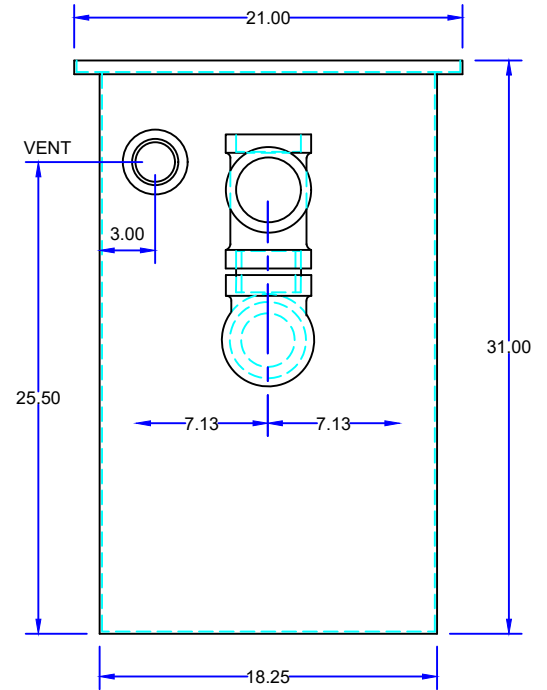
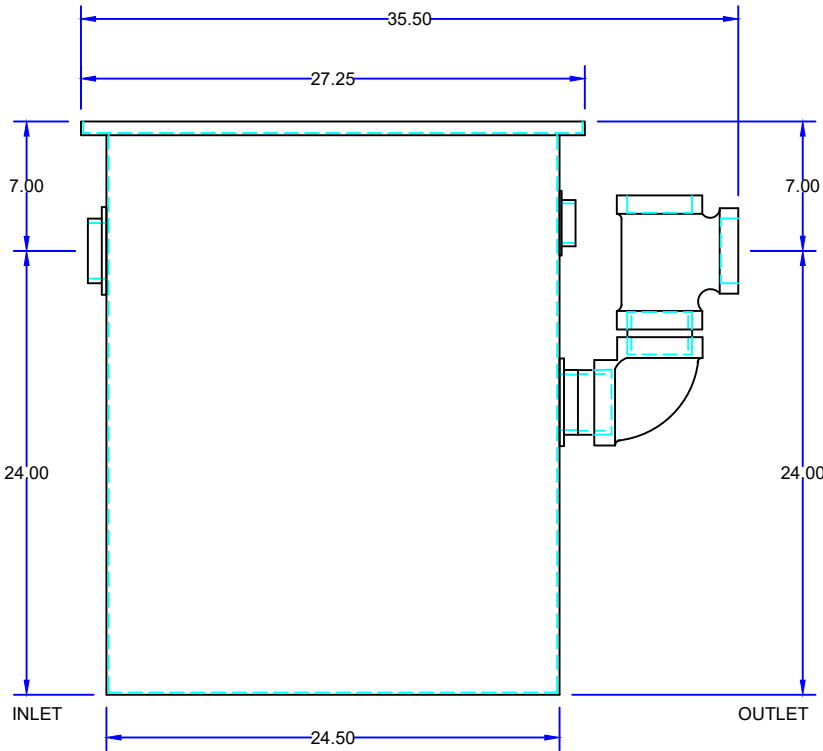
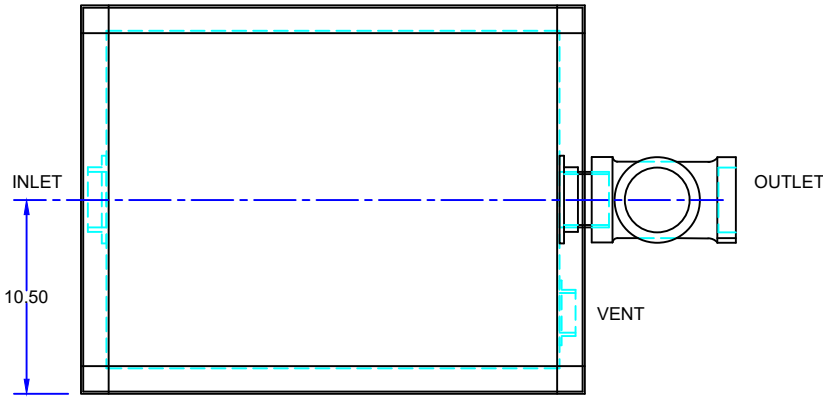

SPECIFICATIONS

Rockford Model RLS-2635 all welded 10 Ga. steel separator, 40 gallon static holding capacity, 3.00" tapped inlet/outlet with 2.00" tapped internal vent connection, visible double-wall outside trap seal, easily removable filter with 3/8" perforations, removable nonskid diamond tread plate cover for flush with floor installation suitable for pedestrian traffic secured with stainless flat head screws, heavy duty leak-proof gasket, OPEX Shop Coat coating inside and bituminous coating outside.

Optional features (Additional cost) listed above

Approved By

Company

Date