



ROCKFORD SEPARATORS

5159 28th Ave ROCKFORD, IL 61109
(815) 229-5077 - FAX (815) 229-5108
www.rkfdseparators.com - rssem@rkfdseparators.com

MODEL NO. RLS-3475

LINT SEPARATOR

DRAWN BY R.P.P.

QUOTE#:

DATE: 10/10/22

JOB NAME:

OPTIONAL FEATURES (ADDITIONAL COST)

- ANCHOR FLANGE
- CLAMP RING
- RECESSED LIFT HANDLES IN COVERS
- EPOXY COATING
- ANODES
- REINFORCED COVER
- STAINLESS STEEL CONSTRUCTION
- INTEGRAL EXTENSION _____ INCHES
- ALUMINUM COVER

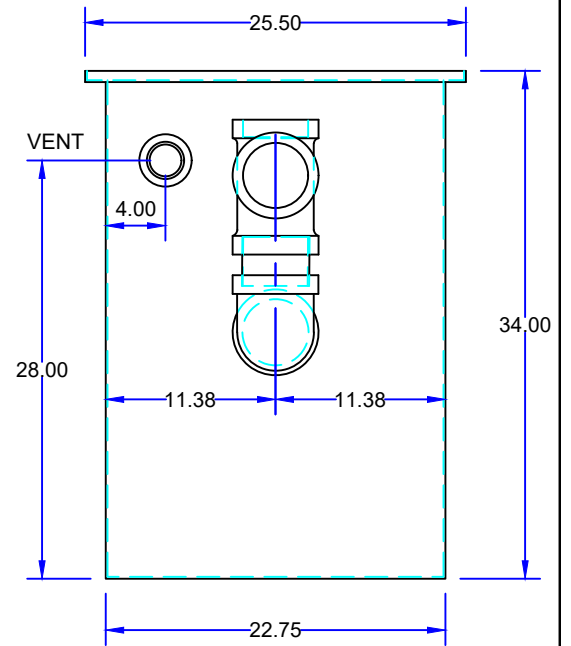
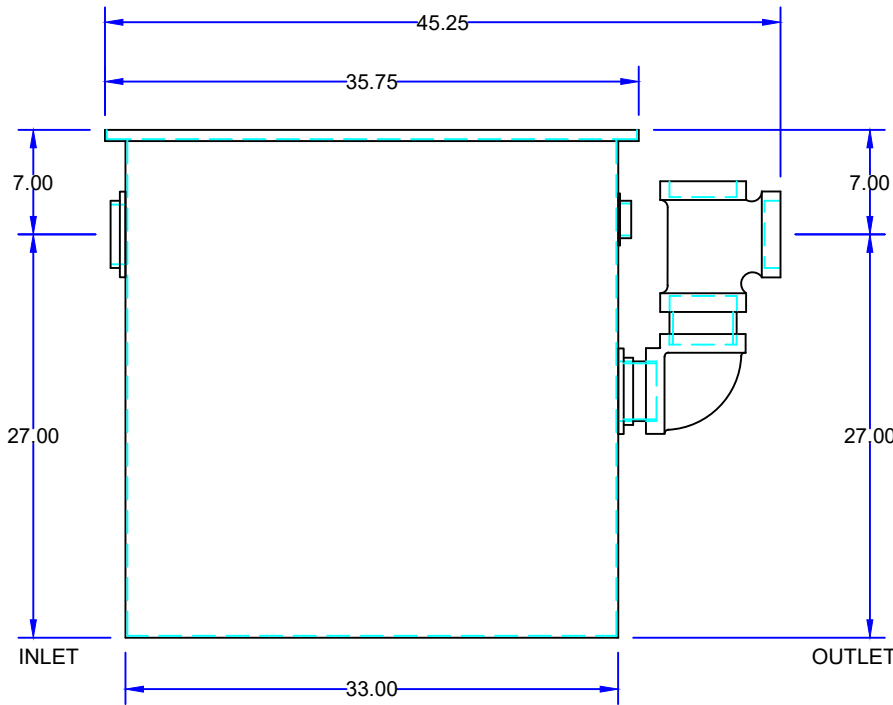
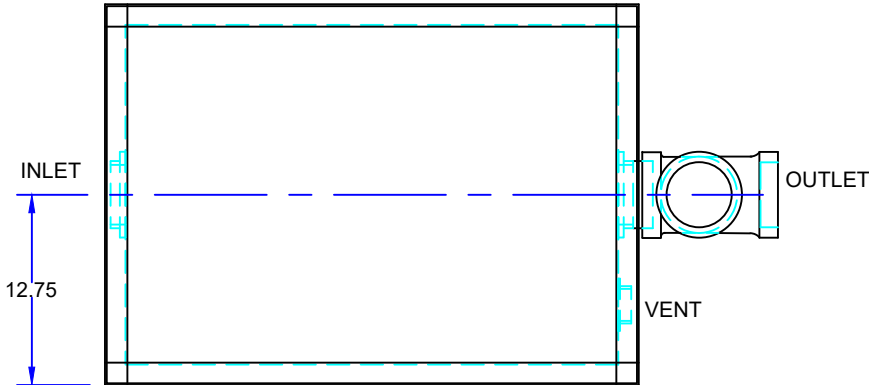

SPECIFICATIONS

Rockford Model RLS-3475 all welded 10 Ga. steel separator, 80 gallon static holding capacity, 4.00" tapped inlet/outlet with 2.00" tapped internal vent connection, visible double-wall outside trap seal, easily removable filter for cleaning, removable 3/8" nonskid diamond tread plate cover for flush with floor installation suitable for pedestrian traffic secured with stainless flat head screws, heavy duty leak-proof gasket, OPEX Shop Coat coating inside and bituminous coating outside.

Optional features (Additional cost) listed above

Approved By

Company

Date