



ROCKFORD SEPARATORS

5159 28th Ave ROCKFORD, IL 61109
(815) 229-5077 - FAX (815) 229-5108
www.rkfdseparators.com - rssem@rkfdseparators.com

MODEL NO. RP-20

GREASE INTERCEPTOR

DRAWN BY R.P.P.

QUOTE#:

DATE: 03/21/22

JOB NAME:

OPTIONAL FEATURES (ADDITIONAL COST)

- ANCHOR FLANGE
- EPOXY COATING
- STAINLESS STEEL CONSTRUCTION
- INTEGRAL EXTENSION _____ INCHES
- INLET & OUTLET SIZE _____ INCHES
- ALUMINUM COVER
- THREADED CONNECTIONS

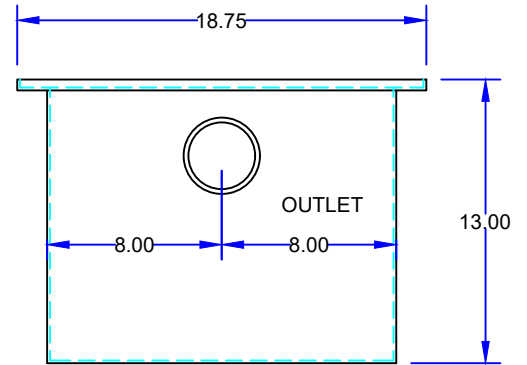
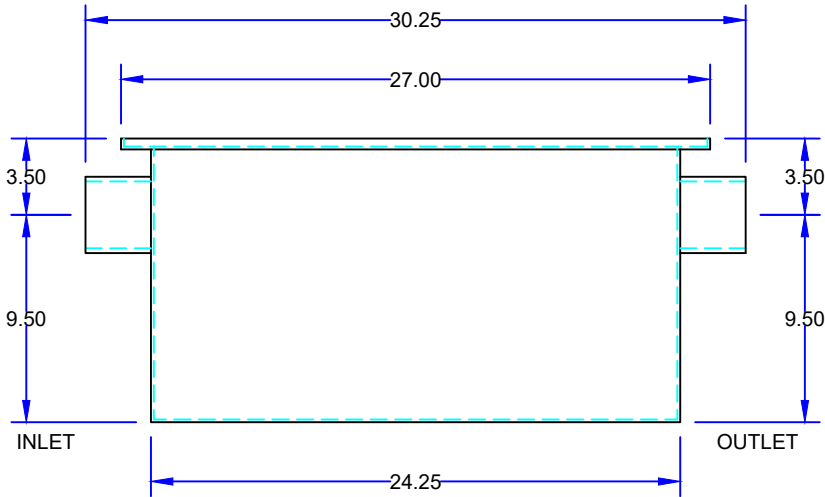
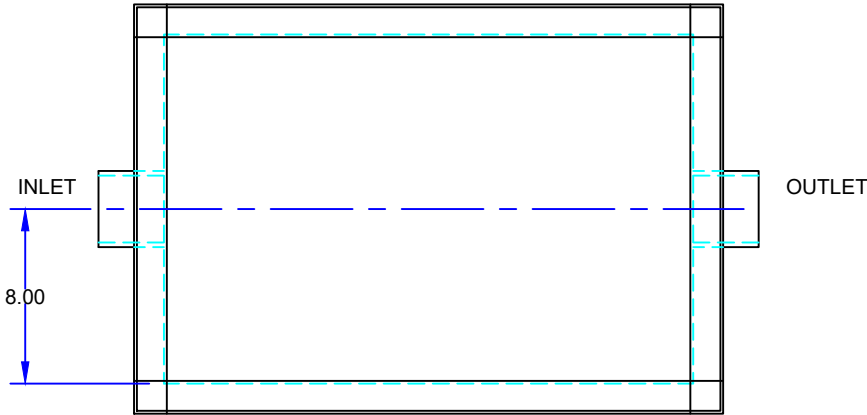

SPECIFICATIONS

Rockford Model RP-20 all welded steel interceptor, for on the floor or flush with the floor installation, 20 g.p.m. intermittent flow, 40 lbs. grease capacity, 3.00" no-hub inlet and outlet connections and flow control device, removable 3/16" nonskid diamond tread plate cover for on the floor or flush with floor installation suitable for pedestrian traffic, secured with stainless steel flat head screws, heavy duty leak-proof gasket, enamel coating inside and outside

Optional features (Additional cost) listed above

Approved By

Company

Date