



Rockford Sanitary Systems, Inc.

ROCKFORD, IL 61125-0963

(815) 229-5077 - (800) 747-5077 - FAX (815) 229-5108

WEB SITE-www.rkfdseparators.com E MAIL-rssem@rkfdseparators.com

MODEL NO. RTO-60

GREASE SEPARATOR

DRAWN BY

QUOTE #

JOB NAME

W.R.W.

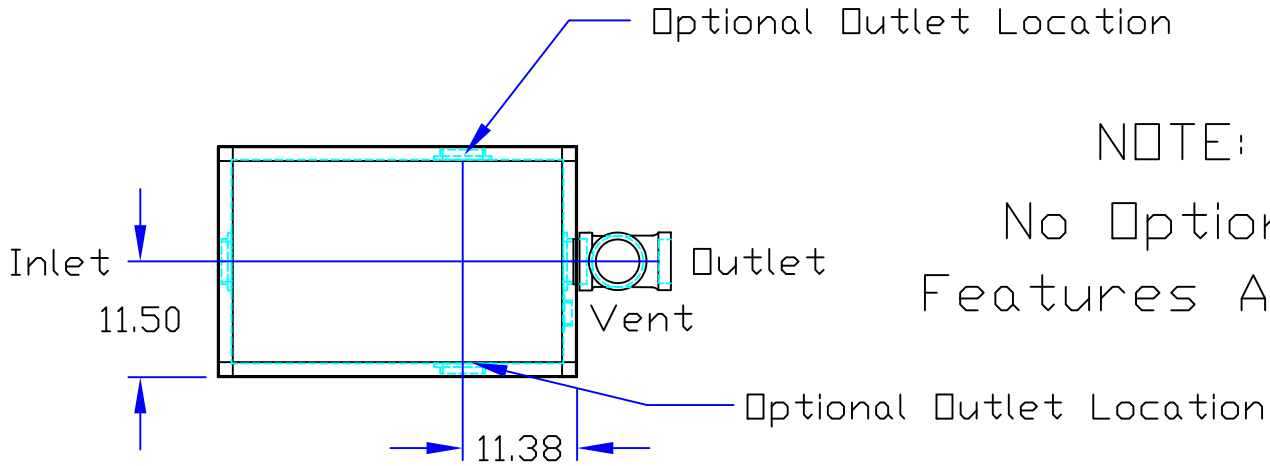

NOTE:

No Optional Features Available

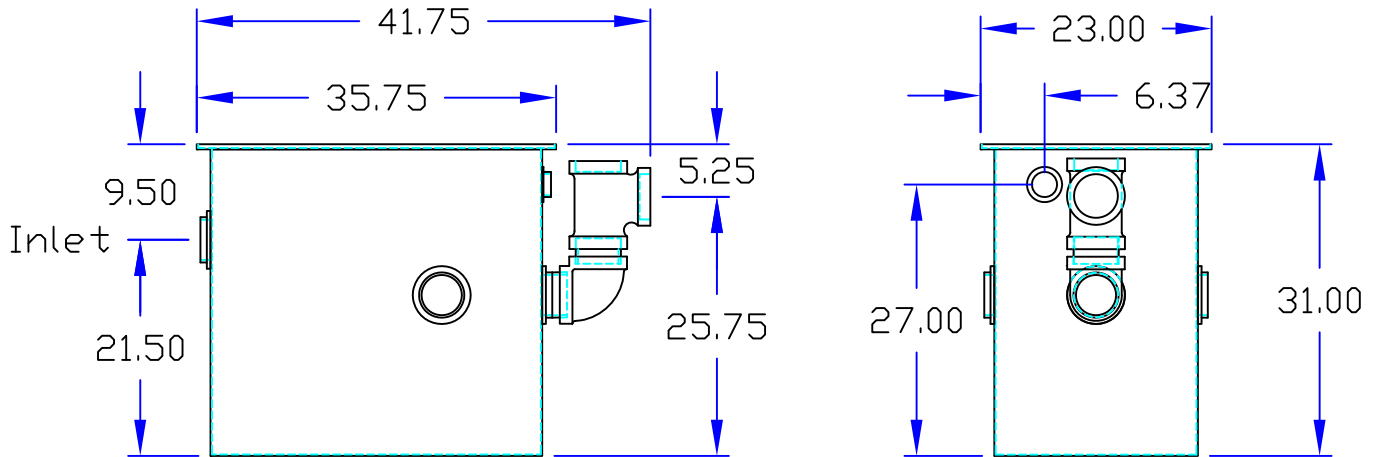

Specifications

Rockford Model RTO-60 all welded steel separator, 67 gallon static capacity, 60 g.p.m. intermittent flow, 4.00" Threaded inlet/outlet with 2.00" tapped internal vent connection, 250 lbs greasy sludge capacity, visible double-wall outside trap seal, separator plate and removeable filter screen, removable 3/16" nonskid diamond treadplate cover for on the floor installation or flush with floor installation suitable for pedestrian traffic secured with stainless flat head screws, heavy duty leak-proof gasket, Enamel coated inside and Outside.

Optional feature (No Additional cost) Bituminous coated outside for flush with floor installation.



Approved By

Company

Date