



ROCKFORD SEPARATORS

5159 28th Ave ROCKFORD, IL 61109
(815) 229-5077 - FAX (815) 229-5108
www.rkfdseparators.com - rssem@rkfdseparators.com

MODEL NO. RLSW-30

LINT SEPARATOR

DRAWN BY R.P.P.

QUOTE#:

DATE: 04/24/26

JOB NAME:

OPTIONAL FEATURES (ADDITIONAL COST)

- ANCHOR FLANGE
- CLAMP RING
- RECESSED LIFT HANDLES IN COVERS
- EPOXY COATING
- ANODES
- REINFORCED COVER
- STAINLESS STEEL CONSTRUCTION
- INTEGRAL EXTENSION _____ INCHES
- ALUMINUM COVER

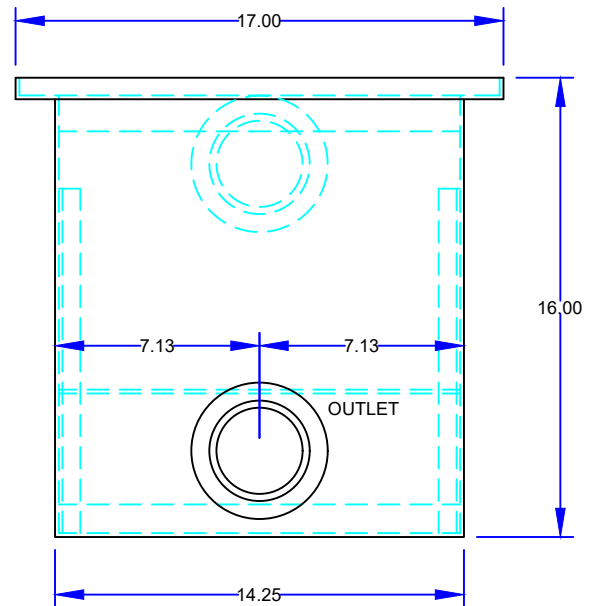
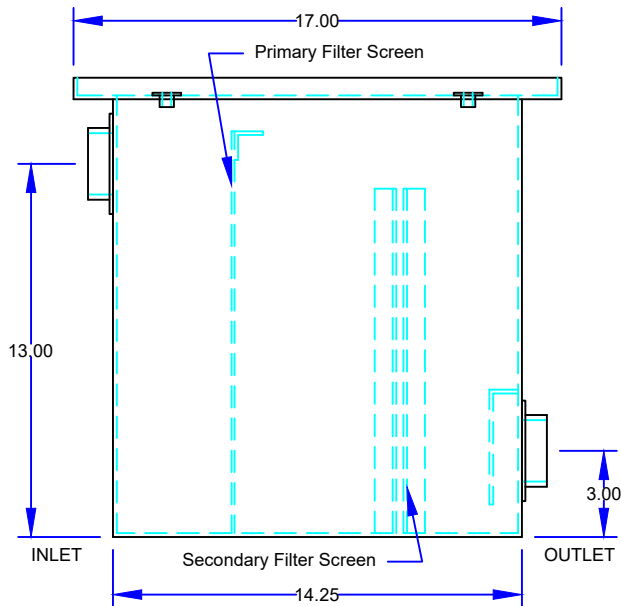
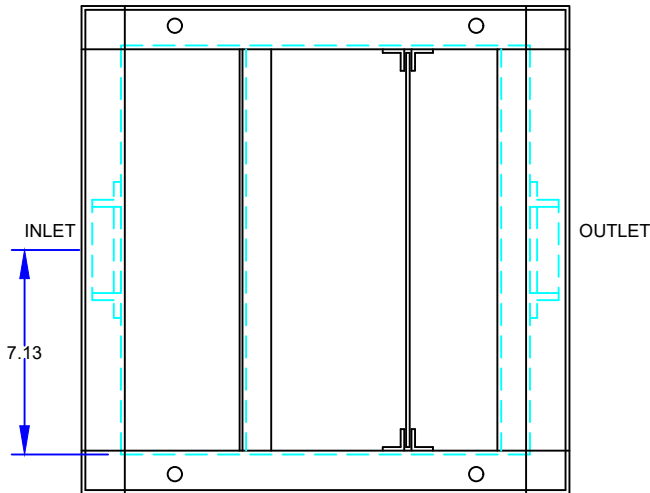

SPECIFICATIONS

Rockford Model RLSW-30 all welded 10 Ga. steel separator, with 30 gpm intermittent flow, 2.00" tapped inlet/outlet, easily removable filter for cleaning, removable 3/16" nonskid diamond tread plate cover for flush with floor installation suitable for pedestrian traffic secured with stainless flat head screws, heavy duty leak-proof gasket, enamel coating inside and outside.

Optional features (Additional cost) listed above

Approved By

Company

Date